

# Football Bounce

**N-FLATABLES**

**Football Bouncer™**  
Unit #BC330101

**INSTRUCTIONS**

*The correct procedures for installing and operating of this inflatable unit.*

Supplement Manual v12.12 ©2012 Great Air, Inc. dba N-Flatables

## Football Bouncer

**Congratulations on your purchase of the Football Bouncer.**

Cutting-Edge-Creations knows that you'll get many hours of excitement from your new purchase. Please read this booklet carefully, being sure to read all of the safety precautions and the do's and don'ts of the ride.

Remember to stake (tether) your inflatable as described in the "Installation and Setup" booklet, and be sure to have a minimum of (1) trained operator as defined in the booklet.

Once again, we thank you for doing business with us, and call us if you have any questions.

Sincerely,  
**N-Flatables / Cutting-Edge-Creations**

**N-FLATABLES**  
**Cutting-Edge-Creations**

2955 Lone Oak Circle, Suite 7  
Eagan, MN 55121 USA



Toll Free 1-800-811-7002 • Local 651-209-8600 • Fax 651-925-0215  
[www.cuttingedgecreations.com](http://www.cuttingedgecreations.com)

## FOOTBALL™ SIGNATURE BOUNCER

H W L  
18'6" x 15'6" x 18'  
UNIT #BC330101

**1-Piece Unit includes:** (1) removable covered roof, (1) giant deflation zipers, tether kit: (4) top tethers, (4) bottom tethers, mattress reinforcement strips and carrying bag. Recommended load: (5) patrons over 34" tall, maximum height not to exceed 60" tall, 150 lbs. suggested maximum weight per patron.

Recommended Number of Installers	Number of Operators	Maximum Number of Patrons
1	1	5

Suggested Max Weight per Patron  
**150 lbs.**

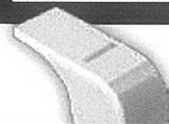

Use Whistle for Control

Total Patron Weight  
**750 lbs.**

This Unit Requires 1 Blower(s) to Function Properly.  
CEC Suggests the following Blower Types:  
• High Volume Output..... 1.0-1.5 hp; 810 CFM

All information included in this supplement is kept current and up-to-date. N-Flatables reserves the right to update this information from time to time as needed.

### ⚠ Safety Notice ⚠

All materials have been tested and comply to **NFPA 701** Large Scale Test and the California Title 19 fire rating test. This Inflatable Amusement Device complies to the **ASTM F2374-10** standards for safety, where applicable to the specific use of this Inflatable Device. Instruction Supplement and General Installation Manuals are included with this unit.

It is **YOUR RESPONSIBILITY** to read and follow these important instructions to prevent injury for your patrons using this device!

Minimum CFM requirement for this inflatable is **810 CFM**. NO Maximum CFM is applicable.

Minimum & Maximum Height	No. of Stakes & Minimum Stake Length	Indoor Weight Container Anchors	Outdoor Hard-Surface Anchors*
34" Min. 60" Max.	(4) 40" Long	(4) 200 lbs.	(4) 400 lbs.
	75% Buried	50 lbs. Per Container	100 lbs. Per Container

\* All outdoor weight containers **MAY NOT** comply with all state or municipal tethering requirements for inflatable devices.

**⚠ ALWAYS contact the utility company before pounding stakes into the ground! ⚠**

# FOOTBALL BOUNCER

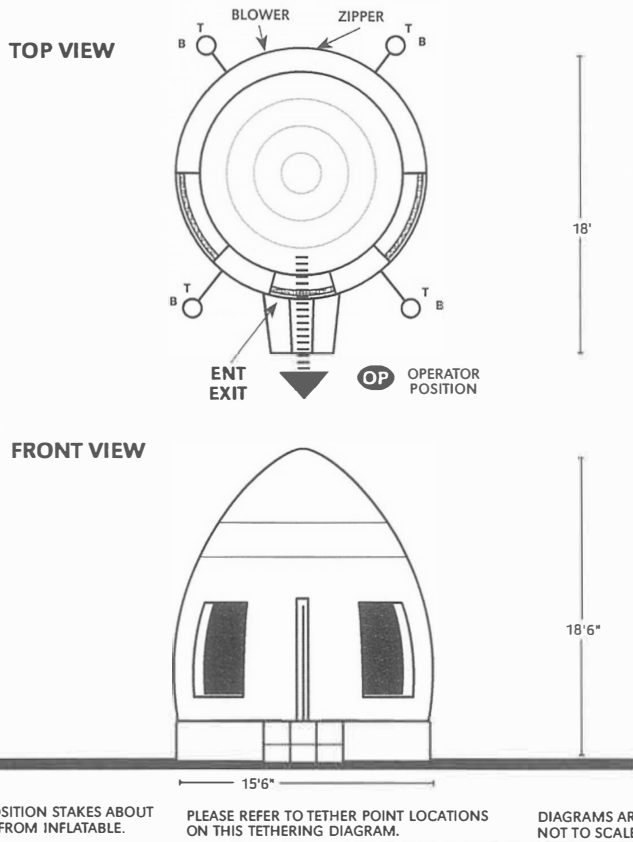

## Directions

- Read instruction booklet.
- Remove unit from storage bag.
- Position on a level ground area approximately 24' x 21'6".
- Install ground stakes, at least (4) around perimeter.
- Loosely tie tethers to ground stakes.
- Attach (1) blower(s) to tubes, making sure Velcro strap is firmly secure.
- Close zippers & flaps on all locations of unit and make sure they are secure.
- Connect each blower to its own power source. *Keep in mind that each blower used will require a constant supply of 110-volt, 20-amp power.*
- Turn blower system on and guide the unit until it is fully inflated.
- Secure all tethers after the unit is fully inflated.
- Do a safety check of blowers, slide & climb covers.
- Do not operate this unit in winds in excess of 15 mph.

**NEVER LEAVE THIS RIDE UNATTENDED!**

### KEY TO DIAGRAM

- T = Top Tether
- B = Bottom Tether
- ENT = Entrance
- EXIT = Exit
- ||||| = Evacuation
- BL = Blower Locations
- ZIP = Deflation Zipper
- OP = Operator Position

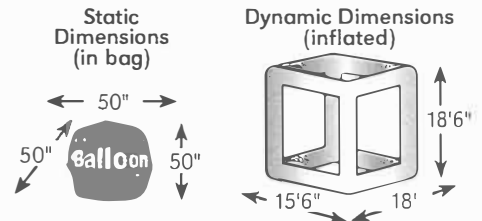

## ✓ DAILY INSPECTION CHECKLIST OF INFLATABLE

- Check to see if blower(s) is attached properly and securely to inflatable device.
- Make sure all deflation zippers are closed and secured.
- Check blower electric attachment to be sure it has been properly plugged in to receptacle.
- Make sure blower system has no obstruction restricting intake on sides of blower.
- Check inflation of unit to be sure it is properly inflated to correct firmness.
- Make adjustments to slide and climb covers if necessary to proper secure position.
- Make sure all tether points are attached properly.
- Check netted areas and sun covers to be sure they are in place and in good condition.
- Crawl through (if possible) inflated device and examine all visible seams for stretching or wear. If problems with any seams contact manufacturer to advise.
- Inspect the inflatable for loose stitching causing open seams, torn netting, worn holes in bottom or sides of unit. If found, cease use and repair immediately using supplied repair kit. Or if a hole or seam is open more than 1 - 2 inches, professionally repair using 207 polyester thread from a reputable inflatable repair center.



## Catastrophe!

This type of catastrophe can always be avoided by proper tethering, utilizing 40" long ground stakes, and by having trained operators on duty and avoiding inclement weather (such as high winds i.e. winds in excess of 15 m.p.h.).

## Important Notice:

Specifications for Inflatable Devices may change based on reconfigurations that may be required for the proper use of an inflatable device.

These changes may include, but not be limited to, the following:

- 1) Maximum Heights of Patrons.
- 2) Minimum Heights of Patrons.
- 3) Number of Patrons (on a device at one time).
- 4) Maximum Weight
- 5) Number Of Stakes
- 6) Size of Stakes
- 7) Number of Blowers
- 8) Overall physical dimensions of the device.

Any noted current changes made to any inflatable device will be updated on our website: <http://www.cuttingedgecreations.com>.

# Step by Step Procedure: Football Bouncer™

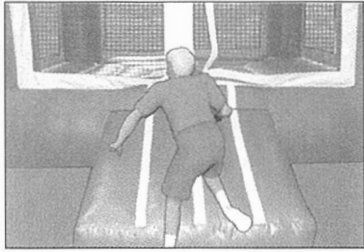

1. Step onto ramp. Children should enter on their hands and knees.



2. Enter bouncer by going through the netting opening.

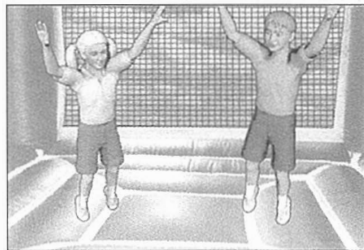

3. Once inside, start jumping around on the mattress.



4. Exit bouncer with the help of an operator.

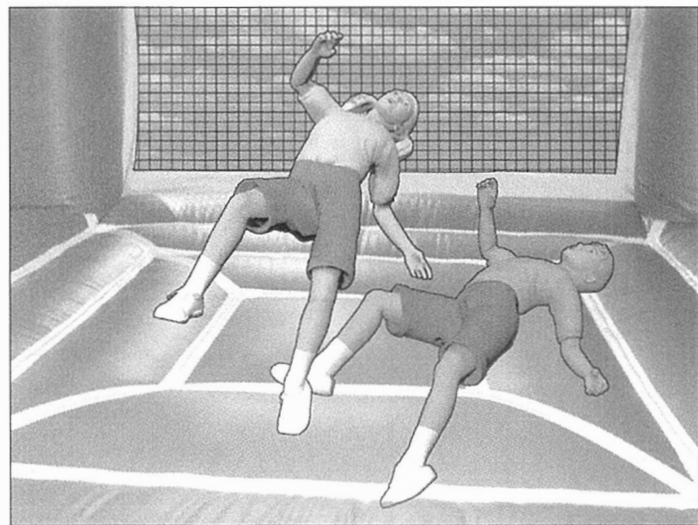

**Be sure to leave room  
between you and others!**

**Improper use of this inflatable  
may cause serious injury!**

Operator Take Control...  
**Use Whistle!**

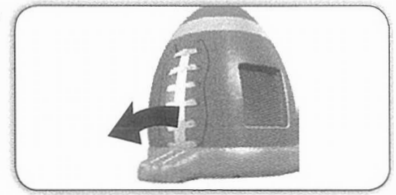

**ASTM Standard #F7324-06 6.6.1**

Operators & attendants shall incorporate the use of whistles or other devices or signal equipment & take appropriate action at the first sign of misbehavior or violation of posted rules.

### Evacuation Procedures!

The blower tube has an automatic air flap that reduces the loss of air if the blower system goes off. In the event of a power outage or emergency take-down, direct patrons off the inflatable as shown by arrows in the diagram shown above.

**Make sure all operators understand the proper procedures for using this inflatable, and that passengers must follow the rules.**

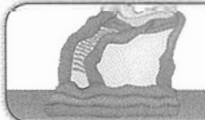

### Deflation Rate of Inflatable:

Type of Testing: Observed

Deflation Rate to unsafe conditions: 3-5 minutes.



### Avoid Contact with Others!

Passengers must be instructed to use or ride unit individually. Do NOT allow double-riding, as accidents WILL happen!



### Do Not Hit Your Head!

DO NOT dive or enter unit head first, as head or neck injuries may occur!



### Keep Landing Areas Clear!

Operators should not allow participants to land on one another. Accidents WILL happen!



### Instruct Safety!

Instruct riders to follow the safety rules located on entrance side of unit. NO flipping, as injuries may occur!



### Watch Out for High Temps!

DO NOT operate when temperatures exceed 90-degrees. Watch for early signs of heat exhaustion and for dehydration.

## ! Important! Use and Indemnification: !

"Buyer" (person, company or entity purchasing the inflatable product or device), is solely responsible for the manner of use of the products and other equipment purchased from N-Flatables. "Buyer" is solely responsible for all signage, labels and warnings to consumers or other users of the products and equipment, and for any and all other acts necessary, including user warnings and limitations (e.g., weight, height, age, number of participants and medical condition limitations), to ensure the safety of the users. "Buyer" acknowledges that they have received, read and fully understand all necessary instructions for the safe setup and operation of their Cutting Edge Creations inflatable product or device. "Buyer" agrees to operate their Cutting Edge Creations inflatable product or device according to the instructions established by Cutting Edge Creations. "Buyer" agrees to operate their inflatable product or device according to all state and local requirements. "Buyer" agrees to train any person(s) operating the inflatable product or device in the safe operation of the inflatable product or device including safe handling of emergency situations. "Buyer" shall use proper stakes, tie-downs, and other applicable devices necessary to ensure the safety of users and the general public. "Buyer" agrees to indemnify, defend and hold harmless N-Flatables and N-Flatables Insurers from actions and claims of third parties, including customers of "Buyer" and users of the goods and products sold to "Buyer", arising out of or in connection with the use of the goods and products herein described or resulting from the breach of the provisions in this Confirmation of Order by "Buyer". In the event N-Flatables is required to commence an action to enforce this provision, "Buyer" shall pay all of N-Flatables legal costs and expenses.



1612 N Broad Street  
 Lansdale, Pa 19446  
 (215) 362 - 7368

44 W Ridge Pike  
 Limerick, Pa 19468  
 (610) 489 - 2334

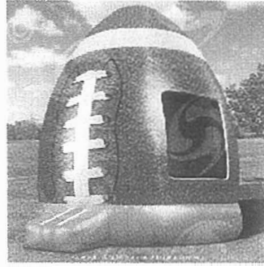

[ slide bar to select image - click to open ]

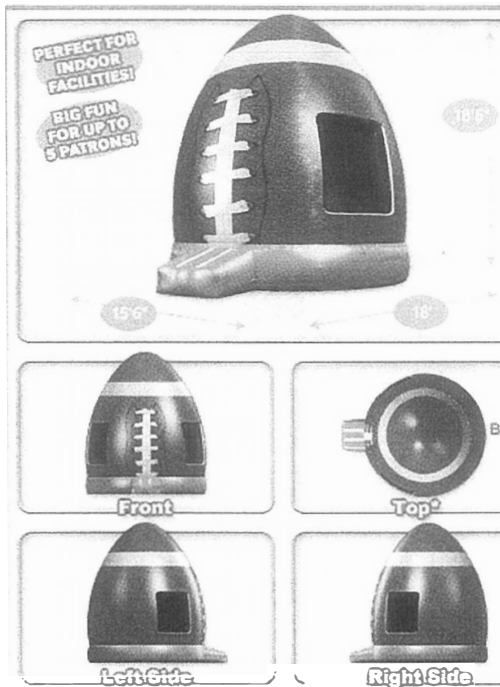

⊙ B Indicates Pre-Installed Blower Tube locations.  
[Click to view more images](#)

### FOOTBALL BOUNCER

Get your game on with the perfect bouncer that complements backyard BBQ's and sport-themed events!

Our Signature™ line of bouncers and combos are designed with our customers in mind. Featuring the highest quality 18oz lead-safe vinyl, our famous durable construction (including up to 6 rows of stitching on high stress areas), and dazzling themes, these inflatables will help set you apart from your competition. All of that, and at an affordable price! Come on, wouldn't this look fantastic on your business card?

Details

SKU	BC330101
Height	18'6"   5.64m
Width	15'6"   4.8m
Length	18'   5.49m
Occupancy	5
Occupant Min. Height	34"
Occupant Max. Height	60"
Max. Occupancy Weight	750 lbs. (150 lbs. ea.)
Shipping Bags	1
Installers	1
Operators	1
Blowers Required (not included)	1
<b>Suggested Retail Price:</b>	<b>\$3,125.00</b>
<b>Sale Price:</b>	<b>\$2,495.00</b>

**Package Price:** \$2,307.88\* *WHEN YOU ORDER ANY 3+ INFLATABLES*

Quantity 1 ▾

[Add to cart](#)    [View cart](#)    [Checkout](#)